

# INSTALLATION OF THE ANCHOR

1. Start with a folded RAFA

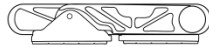

2. Press the leg buttons (1) in order to change the leg's angle to the desired position. Start with the rear leg to set an "L" anchor (1.a), clamp (1.b) or "L" with a supportive leg (1.c)

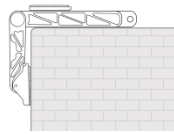

1.a

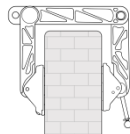

1.b

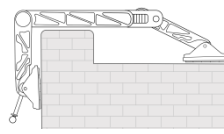

1.c

3. Press the slider button (2) in order to extend the length of the anchor. You can get an extended "L" anchor (2.a), an extended "L" anchor with a supportive leg (2.b), an extended clamp (2.c) or an extended clamp with angles to avoid large edges or surfacing (2.d)

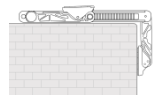
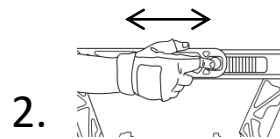

2.a

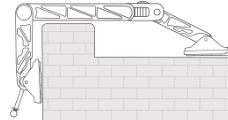

2.b

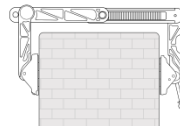

2.c

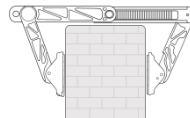

2.d

4. Press the leg handle down (3) to lock the anchor firmly in a clamp position

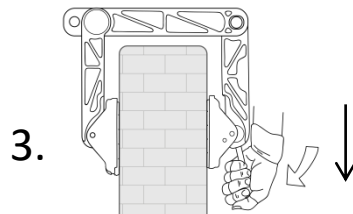

# RAFA<sup>®</sup>

## ROOF ACCESS FAST ANCHOR



### RAFA PARTS

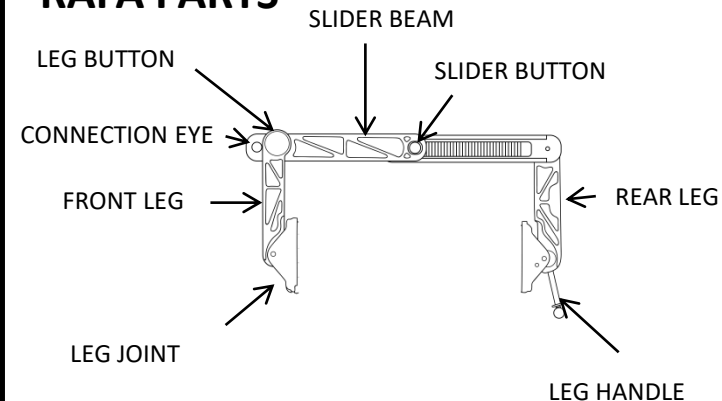

### GENERAL INSTRUCTIONS:

- Use only standard gear, checked by a certified person
- Use the product only after proper training from a certified guide.
- Do not use the product without reading the instructions.
- Check the product functionality before every use. If there is any doubt, do not use it until consulting with the manufacturer.

# USING THE RAFA ANCHOR

The RAFA is the most versatile temporary anchor point. shown below some of the common options :

a. Use as a clamp for concrete beams, steel beams, walls, window edges. Make sure that the clamp fits tightly and the lever is locked.

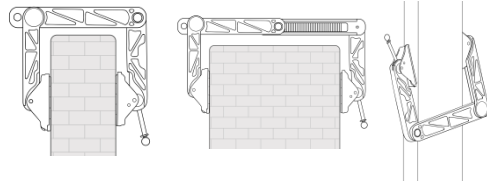

b. Use in an "L" shape for flat roofs.

**Caution!!** Any upward movement can pull the anchor out of place. If possible, extend the slider beam as much as you can to gain more stability

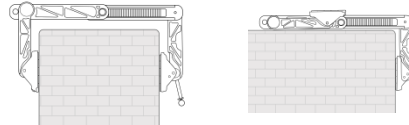

c. Use as a "L" shape with supportive leg when the roof has a small edge

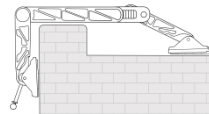

d. Use as an angled clamp when there are edges or surfacing on the beam or window

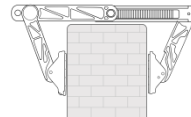

# RAFA<sup>®</sup>

## ROOF ACCESS FAST ANCHOR



## CONNECTING TO THE ANCHOR

Use the connection eye in order to connect a rope or a ladder to the anchor using a standard carabiner or a sling (4)

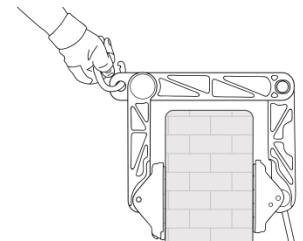

When used as an "L" anchor with a supportive leg, use the window in the front leg in order to connect the sling if needed

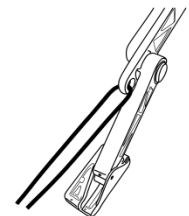

# SAFETY INSTRUCTIONS FOR USING THE RAFA

The RAFA is a portable anchor intended to be used as part of a personal protective equipment system

The use of the product is only for those who received proper training from a certified guide.

Use the RAFA only with standard gear .

The load must be applied to the RAFA only along the axis of the slider beam or below it

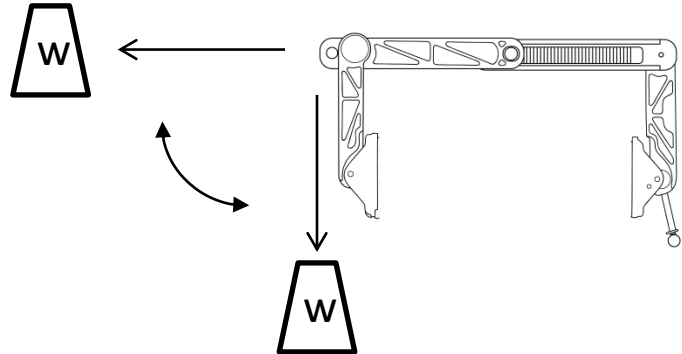

**The RAFA is designed to carry one person only, more than one person on the anchor may result in forces applied in an undesired direction or in an overload!**

Before attaching the RAFA to a wall, make sure that the surface is as flat as possible and stable.

After locking the lever, make sure that the anchor is stable and will not move.

In order to release the handle you need to pull up the safety lock at the top of the lever.

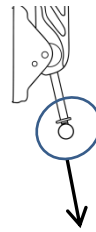

# RAFA<sup>®</sup>

## ROOF ACCESS FAST ANCHOR



### RAFA SPECIFICATIONS

Minimum breaking load, as a clamp- 1300 kg

Maximum working load 200 kg

Weight – 2.8 kg

Folded dimensions :  
5cmX11cmX8cm  
(13.7inX4.3inX3.1in)

Material – Aluminum 7075

# RAFE SAFETY CHECK AND MAINTANANCE

The RAFA should be stored in a dry and cool place.

Always check the RAFA before and after usage.

The sliding beam, the legs joints and the lever should all move freely.

If there is any severe damage to the metallic parts or any signs of rust or corrosion, stop using the anchor immediately and contact Highnovate Distributor for instructions.

Clean the RAFA from dirt, sand or mud with a wet cloth and dry thoroughly before storage. If there is still dirt in the moving parts use air pressure to remove it.

Do not disassemble the anchor without getting permission and training from Highnovate.

If any signs of significant wear appear on the legs rubber pads, replace it before using the anchor again. A replacement kit is available from Highnovate.

# RAFA<sup>®</sup>

## ROOF ACCESS FAST ANCHOR



## Rappelling on the Anchor

Use the RAFA like any other anchor, connect a carabiner and belay or rappel from the anchor

Place the anchor in line with the direction of load to be applied to it.

The anchor is designed for one person and for a single rope. If you need a second rope use another anchor.

Specific training for the RAFA is available, contact Highnovate for details.

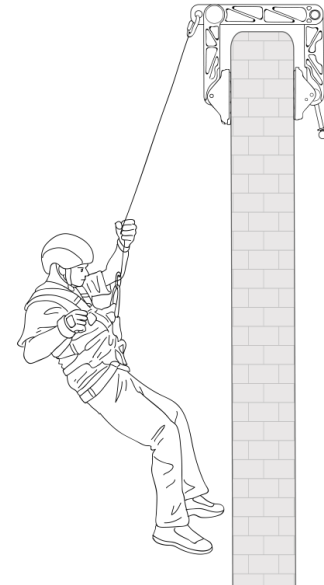

[info@highnovate.com](mailto:info@highnovate.com)  
[www.highnovate.com](http://www.highnovate.com)