



HELIX

Rigid Ladders



Helix Operations provide a complete capability for vertical access and rescue in mountain, maritime and urban environments.

We are based in the mountains of North Wales and have a heritage of over 40 years supplying tactical climbing solutions to end users. Over that time, we have worked with and become a main supplier of tactical climbing equipment to the UK MOD and have provided equipment and systems to many other nations.

The capability offered by our close relationship with DMM has been extended by partnering with manufacturers such as CTOMS, Henriksen, HQH, Protection, Rock Exotica, Highnovate and Cadex Defence to offer complete solutions for working at height in a tactical environment.

ICAGE: U1AG3
Company Number: 10316654
DUNS: 221986629



To be the leading worldwide provider of comprehensive vertical access, rescue and mobility capabilities to the tactical operator in the mountain, urban and maritime environments.

To support vertical access operations for the tactical operator with a range of services including:

- Advice
- Equipment
- Training
- Servicing

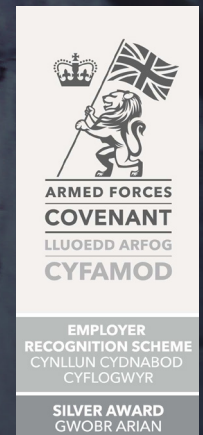

Key Brands

REBS®

REBS supply many critical components of any maritime or urban access system. Rapid Entry Boarding Systems - the best maritime boarding equipment that also works well for urban operations. They supply the best grapnel launchers and the lightest carbon ladder systems on the market.



HQH SYSTEM

Robust carbon ladder systems - these are the go to ladders if TLC is in short supply. The FIX-LITE being the new ladder of choice for dismantled troops in urban environments with the ATV carbon bridge ladder demonstrating how tough carbon can be.



ATLAS DEVICES

The best motorised ascenders on the market with a real-life combination of versatility, ruggedness and battery life that is hard to beat.

CTOMS™

CTOMS was founded on the concept of evolving tactical medicine and expanded to encompass aspects of remote and improvised rescue. A key part of this evolution was the development of the TRACE™ system as micro rope system with a comprehensive capability that includes access, egress, hauling and high-lining. CTOMS are our longest standing partner and Helix are one of the very few authorised providers of training for the TRACE™ system.

LIBERVIT

LIBERVIT have 25 years of experience in design and manufacture of hydraulic tools and manual equipment for the industry, the special forces and the rescuers.



BREACHING

SET Swedish Entry Tools is a renowned manufacturer and supplier of premium quality entry tools. With a strong commitment to precision, durability, and innovation, SET Swedish Entry Tools has established itself as a leading provider in the market.



The DMM International group specialise in the manufacture of equipment and systems for operating safely at height. They have proudly manufactured all their hardware in the United Kingdom since 1981 and over that time they have established a reputation for innovation and quality.

As part of the same group of companies Helix Operations rely heavily on DMM to design, prototype and manufacture much of the core product in our range.

An impressive micro rope system that is very intuitive to use, fast to deploy and incredibly robust. The system that came top in a recent egress system tender and impressed with its ability to meet the criteria of EN341 with a 160kg load.

PROTECTION



Innovative rescue equipment designed and made in their factory in the USA. The range includes products that complement the DMM range of hardware - the Aztec pulley system, the Omni pulleys and the Arizona Vortex are all unique products that we are proud to offer.



Forward thinking equipment and systems designed by former operators to address gaps in current vertical assault capability. The QRAB is a class leading descender for medium diameter ropes that allows fast disengagement whilst the RAFA portable anchor gives security where normal anchors are not viable.



Precision engineering from the Canada that specialises in high end rifle systems, but also produce the best small ledge hooks on the market.

Marlow

Designed and manufactured in the United Kingdom with a reputation for outstanding quality and a long history of providing specialist rope solutions to military and rescue units. Marlow Ropes have a proven record as a key manufacturer of quality ropes for access, rescue and specialist products for use in helicopter operations.

Rigid Ladders Introduction



Ladder technology has moved forward rapidly in the last few years. Composite solutions from REBS and HQH allow for extreme weight savings whilst increasing hanging and bridging strength. Unsupported bridging lengths are reaching 4 and 6 meters with the latest versions of the Ladcarb range. Aluminium ladder options can be the preferred option of some end users with ladders like the ATLAS ATL providing excellent packability and a rapid deployment time.

Our brochure will cover our full range of rigid ladders and their key features. We include all specifications, how each ladder compares in terms of standard set sizes, maximum ladder reach, and weight.



Comparing Rigid Ladders

Product Description	Construction	Max Reach	Configurations (MBL)*				Further Capabilities				Certification
			Leaning	Hanging	Bridging	Stretcher	Halo	Window Breaking	Assault Platform		
Alpha 7	Aluminium Folding Ladder	6.4m	450kg	300Kg (up to four sections)	250kg (up to 4 sections)			•			
Atlas Tactical Ladder	Aluminium Folding Ladder	4.6m	181 kg	181kg	181 kg	•	•				
Atlas Tactical Ladder Narrow	Aluminium Folding Ladder	4.6m	181kg - 362kg	181kg - 362kg	181kg - 362kg	•	•			Compliant with relevant portions of NFPA 1931015, ANSI-ASCA14.2-2007.	
Atlas Tactical Ladder Switchblade (ATL)	Aluminium Collapsible Monopole Ladder System	4.6m		181kg-362kg							
HQH LadCarb ATV Quad Bridge	Carbon Composite, Sectional, Modular, Ladder System	3.5m	450 kg	500 kg	650 kg (1 track)					EN 1147	
HQH LadCarb FIX-LITE SECLAD*	Carbon Composite, Sectional, Modular, Ladder System	5m	400 kg	300 kg	150 kg	•	•	•	•	EN 1147	
HQH LadCarb FIX-LITE SINLAD*	Carbon Composite, Sectional, Modular, Ladder System	5m	400kg	300kg	150kg			•	•	EN 1147	
HQH LadCarb LDC *	Carbon Composite, Sectional, Modular, Ladder System	4.6m	400kg	300kg	200 kg	•	•	•	•	EN 1147	
HQH LadCarb Pole Ladder	Carbon Composite, Sectional, Hanging Ladder System	9.2m		300 kg							
HQH LadCarb Pole Ladder (VBSS)	Carbon Composite, Sectional, Hanging Ladder System	12m		300 kg							
REBS Carbon Multi Ladder (CML)	Carbon Fibre	9m	300kg	1000 kg	200 kg (3 Sections)	•		•			
REBS Tactical Ladder	Aluminium, Sectional, Hanging Ladder System	10m		1000 kg							
REBS Ultralight Pole Ladder	Carbon Composite, Sectional, Hanging Ladder System	12m		2000kg							
REBS Ultralight Pole Ladder Junior	Carbon Composite, Sectional, Hanging Ladder System	12m		1200kg							
TIC Carbon Fibre Ladder	Folding Carbon Ladder	4.5m	159kg	•							
Telesteps Rescue Telescopic Ladder	Aluminium Telescopic Ladder	3.5m	500kg							EN 1147	
	Aluminium Telescopic Ladder	4.1m	500kg							EN 1147	

*Note: There are no no standardised test methods for tactical ladders with each manufacturer adopting their own combination of internal or internal/external standards





Comparing Ladder Max Reach

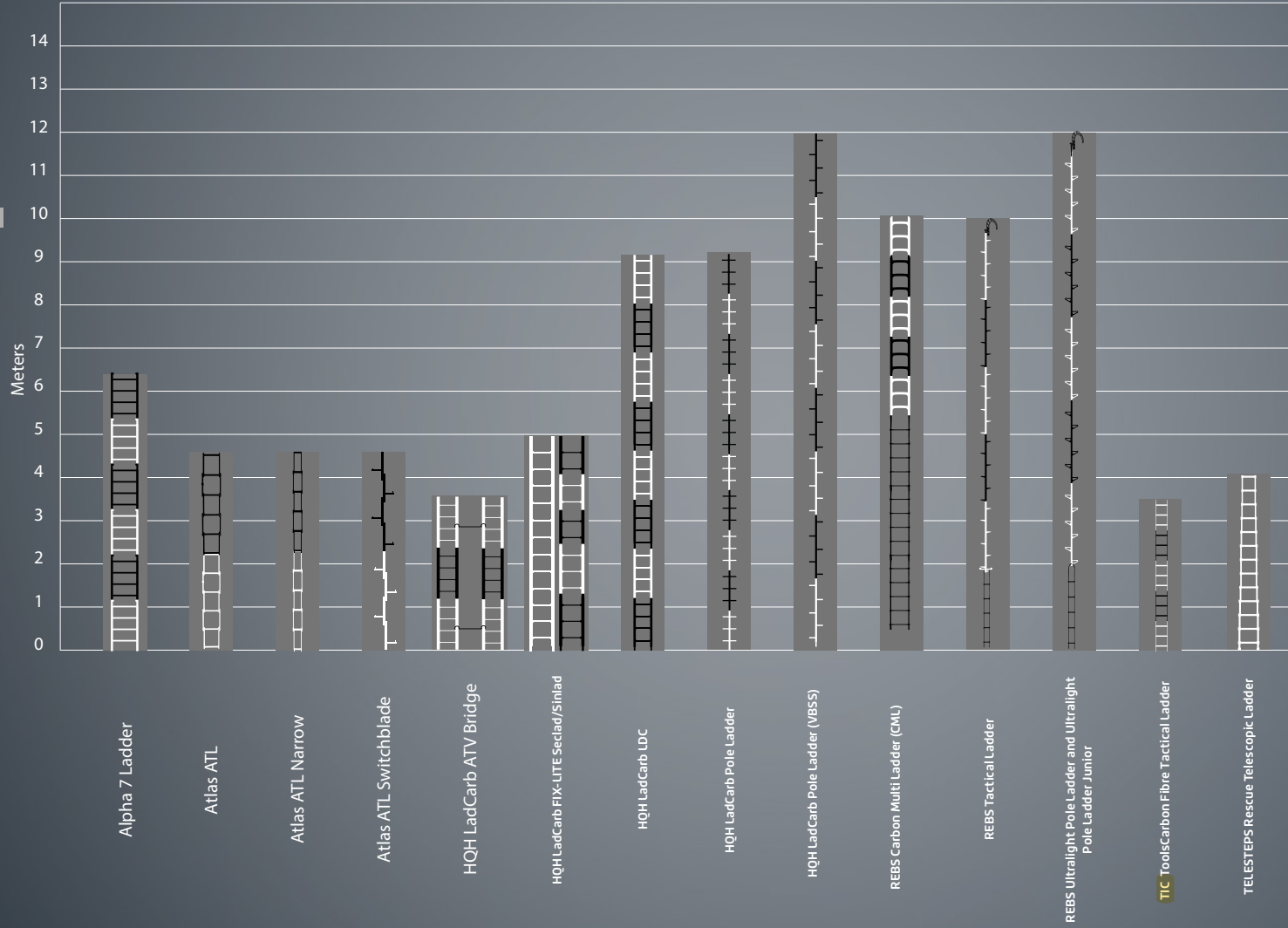

Note : Max Reach may be accomplished using wire ladders.

Comparing Rigid Ladder Individual Section and Max Reach

Product Description	Sections	Weight Per Section	Length Per Section	Max Reach
Alpha 7	3-6	3.4kg	1.09m	6.4m
Atlas Tactical Ladder	2	4.5kg	2.13m	4.6m
Atlas Tactical Ladder (Narrow)	2	4.1kg	2.13m	4.6m
Atlas ATL Switchblade	2	3kg	2.13m	4.6m
HQH LadCarb ATV Quad Bridge	6	4kg	1.22m	3.5m
HQH LadCarb FIX-LITE SECLAD	5	0.9kg & 1.2kg	0.7m & 1m	5m
HQH LadCarb FIX-LITE SINLAD	z	Custom Lengths	Custom 1.4 - 5m	5m
HQH LadCarb LDC *	4	2.8kg	1.22m	4.6m
HQH LadCarb Pole Ladder	4	1.0kg	1m	9.2m
HQH LadCarb Pole Ladder (VBSS)	4	0.9kg -1.1kg	1-1.6m	12.0m
REBS Carbon Multi Ladder (CML)	5	1.85kg	0.9m	9.0m
REBS Tactical Ladder	1	2.3kg	1.6 m	10m
REBS Ultralight Pole Ladder	1	1.7kg	1.7m	12m
REBS Ultralight Pole Ladder Junior	2	0.9kg	0.9m	12m
TIC Tools Carbon Fibre Tactical Ladder	5	1kg	0.7m	4.6m
Telesteps Rescue Telescopic Ladder	1	15kg	0.85m	3.5m
Telesteps Rescue Telescopic Ladder	1	19.2kg	0.85m	4.1m



Hook Ladder Compatibility



Alpha 7 Ladder

Specially designed with covert operations in mind the Alpha 7 foldable Tactical Ladders are a versatile and modular access system that can be used as a leaning ladder, hanging ladder or bridge.

The Alpha 7 Tactical Ladders are compact, strong, simple to use and can be deployed and fully extended in seconds. Deployment is quiet especially when used with the optional rubber wall pads that dampen noise as well as increase stability.

The ladder system is fully modular and the 109cm long sections can be added or removed to create bespoke ladder sizes for specific tasks - the ladder normally uses 3-6 of these segments and this gives access to heights from 3.20m (10.5ft) to an impressive 6.40m (21.4ft). If a hanging ladder is required the hook can be pinned quickly into place.

Made from aviation grade aluminium with CNC precision machined parts.

The ladder can be transported in a specially designed MOLLE backpack harness system.

We can supply a complete system comes which comes with 4 rubber feet, the hook system and a backpack together with the desired number of sections.





Stealthy; option of rubber end pads for noise dampening and grip.

	Lean	Hook	Bridge
MBS	450kg	300Kg (up to four sections)	250kg (up to 4 sections)

 Aluminium Folding Ladder

 Available in Black

 3.4kg per section.

 6.4m Max Reach

 Bridge Ladder

 Leaning Ladder

 Hook Ladder



Alpha 7 Ladder Applications



Leaning Ladder

The Alpha 7 in 3 and 4 section use (AAA3/AAA4) can accommodate 3 operators simultaneously, when spread out accordingly (one operator on each section (bottom section, middle, top section). Overall, this provides a working load of 450kg, when this guidance is followed.

For 5 and 6 section use (AAA5/AAA6) the suggested use is 300kg spread accordingly.



Bridge Ladder

Maximum of 250kg load across 2/3/4 sections (4 section maximum for bridging). The horizontal bridging format can be backed up with a safety line, if the environment and operating time allows.



Hook Ladder

Alpha 7 ladders can be loaded up to 300kg in hook configuration, as long as the accompanying stand-offs are in place.



Alpha 7 Ladder Product Specifications

Product Name	Length	Product Code	Colour	Weight
Alpha 7 Aluminium 3.2 Meters 3 sections foldable ladder black matt finish	3.20m (10.49ft)	A7AAA3-320-109-42-4SB	Black	10.3kg (22.5lb)
Alpha 7 Aluminium 4.2 Meters 4 sections foldable ladder black matt finish	4.27m (14.28ft)	A7AAA4-427-109-42-4SB	Black	13.6kg (30lb)
Alpha 7 Aluminium 5.3 Meters 5 sections foldable ladder black matt finish	5.34m (17.85ft)	A7AAA4-534-109-42-4SB	Black	17.0kg (37.5lb)
Alpha 7 Aluminium 6.4 Meters 6 sections foldable ladder black matt finish	6.40m (21.42ft)	A7AAA6-640-109-42-4SB	Black	20.4kg (45lb)

Alpha 7 Aluminium 3.4Meters 3 sections foldable ladder black matt finish - Complete system with 4 rubber feet, hook system and backpack	3.4m (11.14ft)	A7AAA3-320-System	Black	-
Alpha 7 Aluminium 4.4 Meters 4 sections foldable ladder black matt finish - Complete system with 4 rubber feet, hook system and backpack	4.4m (14.44ft)	A7AAA4-427-System	Black	-
Alpha 7 Aluminium 5.5 Meters 5 sections foldable ladder black matt finish - Complete system with 4 rubber feet, hook system and backpack	5.5m (18.04ft)	A7AAA4-534-System	Black	-
Alpha 7 Aluminium 6.6 Meters 6 sections foldable ladder black matt finish - Complete system with 4 rubber feet, hook system and backpack	6.6m(21.65ft)	A7AAA6-640-System	Black	-

Alpha 7 Aluminium Short Adaptor with rubber ending.	9.5cm(3.7inch)	A7AAA-SH95-ADPT-RBR	Black	-
Alpha 7 Aluminium hook & 2 wall spacers	-	A7HKS-AAA	Black	-
Alpha 7 Backpack	-	A7BCKS-MOLLE-AAA	Black	-

Atlas ATL Tactical Ladder

The Atlas Tactical Ladder (ATL) is a high strength aluminum collapsible bridging, ladder, litter system ideal for jump, maritime, and urban lean-to and hook and climb tactical access mission requirements. The ATL can be joined to reach heights of 4.6m.

The ATL (Atlas Tactical Ladder) system features a sophisticated design optimised for an exceptionally high strength-to-weight ratio. This allows for durability, versatility, and minimum weight (4.5kg) for a 7ft/2.1m length without sacrificing strength or height.

The ATL is the foundation of an ultralight Litter/Ladder/Bridge system designed for operators conducting austere special operations missions. Built on a core Atlas Devices ladder technology backbone, the ATL system combines the packable, height-conformable strength and tailor-ability of a ladder and bridge with the speed, efficiency, and security of a vertical/horizontal hoist-able patient litter. The integrated handle designs enable effective patient manipulation and longer duration carries which provide a multi-mission tool that is useful through all phases of operations.



MBS	Lean	Hook	Bridge
	181kg	181kg	181kg

AI Aluminium Folding Ladder

Available in Black

4.5kg per section.

4.6m Max Reach



Bridge Ladder

Leaning Ladder

Hook Ladder

Emergency Stretcher

Halo

Atlas ATL Tactical Ladder

The Ladder easily collapses down and the space within the frame can provide storage and protection for additional equipment. When collapsed, the system fits entirely within the torso's profile thus enabling unimpeded freedom of movement.

The innovative patented locking joint design enables not just the ability to rapidly deploy and stow the ATL, but also the ability to separate the assembly into smaller sections to optimise load carry and length. This means that the ATL systems weight can be distributed among several people and rapidly reassembled on site. It can also be configured for shorter lengths or deployed as several ladders, making it a single solution for many different missions. The ATL can be joined to reach heights of 5-6m.



The Atlas ATL Ladder joint locking system can be set to auto-locking mode for silent deployment. Compacting into a collapsed mode making it easy to handle.

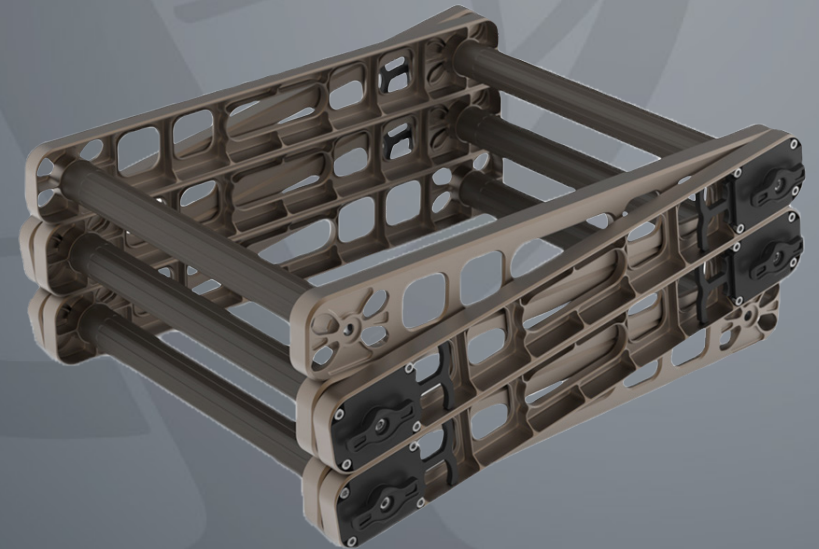

Atlas ATL Tactical Ladder Applications

The ATL is the foundation of an ultralight Litter/Ladder/Bridge system designed for operators conducting austere special operations missions. Built on a core Atlas Devices ladder technology backbone, the ATL system combines the packable, height-conformable strength and tailor-ability of a ladder and bridge with the speed, efficiency, and security of a vertical/horizontal hoistable patient litter. The integrated handle designs enable effective patient manipulation and longer duration carries which provide a multi-mission tool that is useful through primary and contingency phases of operations. ATL is capable of all the following capabilities:

- Leaning ladder
- Hanging ladder
- Bridge
- Artificial high directional system (AHD)
- High Point Anchor
- Hoistable stretcher
- Drag stretcher
- Carry stretcher
- Jumpable

Bridge Ladder

Bridge: Max Bridge 181kg Working load at 2.1m.

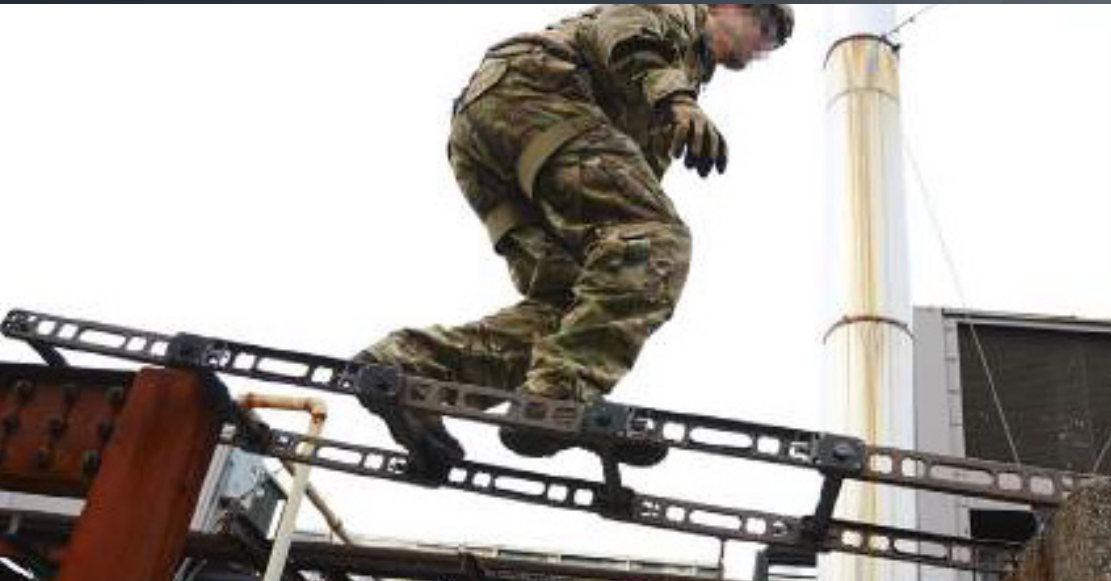

Atlas ATL Tactical Ladder Applications

Emergency Stretcher

Use configuration: Hoisting

Litter mode easily converts between horizontal and vertical hoist modes without the need to tie a knot.

- Hoist bridles rated to 5,000 lbf / 23 kN
- Accommodates patients from 4-7 ft / 1.2 - 2.1 m
- Litter load rating suspended from bridles (average body weight distributed across rungs): >2,500 lbs / 1,134 kg
- Redundant attachment system links to four rungs each side
- Convert from vertical to horizontal configuration in <5 seconds
- Integrated ergonomic carry handles for patient carry and manipulation protect attendant's fingers.
- Rigid frame protects patient and is rated for vertical pivot.

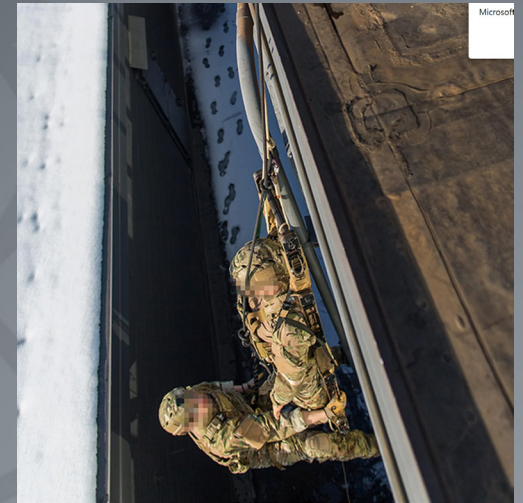

Vertical Hoist

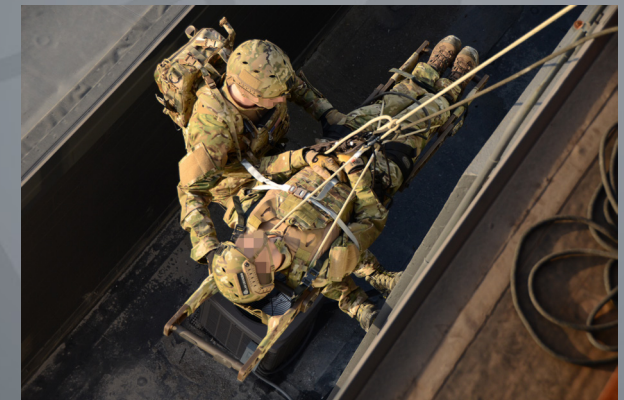

Horizontal Hoist

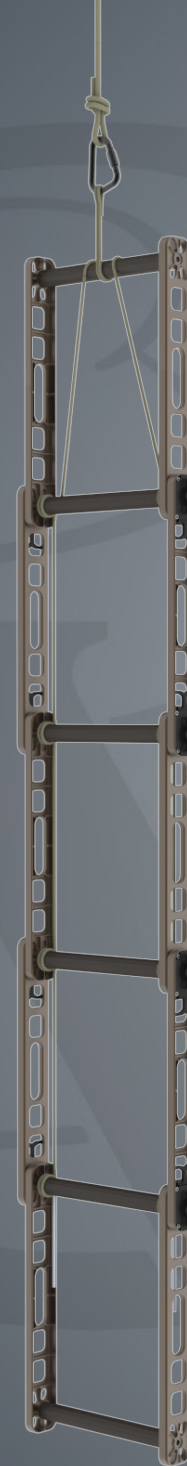

Atlas ATL Tactical Ladder Applications

High Point

Use configurations :High Point.

The ATL with hoist bridles can be set up to provide a structural A-frame for use as a high point or redirect for high angle operations (ex. confined space, roof edge transition).

- 400 lbs / 180 kg Load rating in all configurations
- Adjustable Bridle Footprint
- Variable High Directional Heights
- Single Point load rated
- Load Share Anchoring Capable



Atlas ATL Tactical Ladder Narrow

The Atlas Tactical Ladder (ATL) Narrow is a high strength aluminium collapsible bridging ladder and litter system. It is suitable for jump, maritime and urban lean-to and hook and climb tactical access mission requirements.

The width is 18.6cm narrower than the standard Atlas Tactical Ladder (ATL) but the reach is the same at 4.5-5.5m / 15-18ft.

Tool free joining of up to two full ATL Narrow segments to make a 4.6m/15ft ladder and the deployment time is <5 seconds. Secondary positive joint locks can automatically engage on deployment and joints are manually lockable for noise control.

Compliant with relevant portions of NFPA 1931015, ANSI-ASCA14.2-2007.



MBS	Lean	Hook	Bridge
	181kg	181kg	181kg

 Aluminium Folding Ladder

 Available in Black

 4.1kg per section.

 4.6 Max Reach

 Bridge Ladder

 Leaning Ladder

 Hook Ladder

 Emergency Stretcher

 Halo

Atlas ATL Switchblade





The Atlas Tactical Ladder Switchblade (ATL) is a high strength aluminium collapsible Monopole Ladder system which combines the packable, height-conformable strength and tailor-ability of a ladder and bridge with the speed, efficiency, and security of a vertical/horizontal hoist-able patient litter.

A true multi-mission system designed for jump, maritime and urban hook and climb tactical access mission requirements which is built on a core Atlas Devices technology backbone.

The system can be joined together to reach heights of 4.5-5.5 metres /15-18ft and the integrated handle enables effective patient manipulation and longer duration carries.



- 

Hook
181kg
-  Aluminium Collapsible Monopole Ladder System
-  Available in Black
-  3kg per section.
-  4.6 Max Reach
-  Hook Ladder

HQH LADCARB® LDC

The HQH LADCARB® LDC is a unique multi function, modular tactical assault ladder which builds on the robust, performance capability of the FIX-LITE ladder system by making the rungs removable. This allows the LDC ladder system to be more compact which makes transportation in a vehicle or on the man easier.

The rungs can be added to the sides very quickly and there is no compromise on strength compared to the FIX-LITE.

One single rung with the rough and durable anti-slip surface cover, withstands a load up to 500kg which allows the rescue of persons by carrying them over the shoulder.



MBS	Lean	Hook	Bridge
	400kg	300kg	200kg

 Carbon Composite

 Available in Black

 2.8kg per section.

 4.6 Max Reach



 Bridge Ladder

 Leaning Ladder

 Hook Ladder

 Emergency Stretcher

 Halo

 Assault Platform

 Window Breaker



Extremely strong structure. Can endure loads up to 200kg at horizontal position and will carry 3 persons while leaning against a wall. One single rung withstands a load up to 500kg allowing rescue of persons by carrying over the shoulder.

Performs at extreme conditions of +60c/-40c
The ladders unbelievable versatility means that it can be used in extreme conditions without compromising the functionality.

HQH LADCARB® LDC

The standard 4.6m long ladder set consists of four sections which can be quickly and easily dismantled to single parts. The dismantled ladder then fits into a dedicated bag for storage or transport.

The LDC is compatible with the HQH tactical hooks, window breaking tools, stand-off devices, evacuation kits and also with REBS tactical hooks.

Transforms to an emergency stretcher. The ladder can be used for not only ground transportation of patients, but for lifting by winch or fast evacuation under helicopter.



LADCARB® LDC is the only sectional ladder in the world with fully removable rungs. Rails (stiles) can be joined together into an extremely strong multi-purpose pole. The small size allows easy carrying and transportation which makes this ladder perfect for urban or covert operations.

By connecting 8 rails it is possible to build a mast 9.1m high. It can be used for installation of antennas, cameras, radars etc.

HQH LadCarb FIX-LITE

The HQH LADCARB® FIX-LITE is a fully modular and scaleable carbon composite ladder system that can be used as a leaning or hanging ladder, bridge.

The HQH LADCARB® FIX-LITE has two versions, SECLAD refers to the modular system with two lengths, a 2 rung 70cm long section and a 3 rung 1.0m section. This offers a very versatile system with multiple possible combinations of the 2 different sections allowing customization of a ladder set for a very wide range of operations. The FixLite system offers any length of ladder from 0.7 to 5,0 m by mere 30 centimetres.

Whereas, the FIX-LITE SINLAD is a more traditional single section assault This offers a very versatile system with multiple possible combinations of the 2 different sections allowing customization of a ladder set for a very wide range of operations. The FixLite system offers any length of ladder from 0.7 to 5,0 m by mere 30 centimetres.

Both versions are lightweight, a 0.7m length only weighing 0.9kg. Both versions can achieve a max reach of 5m. Designed with ergonomic round rails, and non-slip gripping rungs. Both the SECLAD and SINCLAD versions can use the wide variety of ladder accessories such as raptor feet, window breaking heads and hooks.



HQH LADCARB® FIX-LITE
SECLAD



HQH LADCARB® FIX-LITE
SINLAD



HQH LadCarb FIX-LITE (SECLAD*)

The HQH LADCARB® FIX-LITE is a fully modular and scaleable carbon composite ladder system that can be used as a leaning or hanging ladder, bridge, stretcher, window breaker, assault platform and smoke jump ladder.

The ladder sections come in 2 different lengths; a 2 rung 70cm long section and a 3 rung 1.0m section. The standard base package consists of 4 x 1.0m sections and 2 x 0.7m sections - this allows ladders to be created in multiple lengths to match the height of the access point. Further fine tuning of the ladder can be achieved by using the 18cm long adapter that also allows use on steps, stairwells and uneven ground.

Shorter sections are an ideal solution for urban operations in confined space like ventilation ducts etc. In addition to this, these sections fit into a NATO approved parachuting container which can accommodate 3m long ladder with accessories and other gear.



The ladder packs down to a compact size for transportation and a 5m ladder can be deployed in under 2 minutes.

Characteristics include high strength, low weight, increased impact resistance and precisely adjustable lengths.

MBS	Lean	Hook	Bridge
	400kg	300kg	150kg

 Carbon Composite

 Available in Black

 0.9kg + 1.2kg

 5m Max Reach

 Bridge Ladder

 Leaning Ladder

 Hook Ladder

 Emergency Stretcher

 Halo

 Assault Platform

 Window Breaker



HQH LadCarb FIX-LITE SINLAD*

FIX-LITE SINLAD single ladders can be made according to the specific needs resulting from pre-defined scenarios where using sectional ladders is time consuming.

The best example is attacking hijacked airplanes or hostage rescue operations. Single ladders can be connected together by Dual ladder connectors for faster entry of larger assault teams.



MBS	Lean	Hook	Bridge
	400kg	300kg	150kg

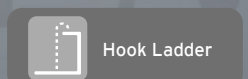
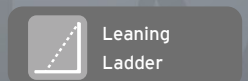
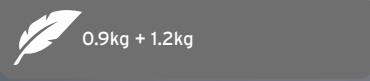
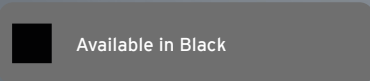
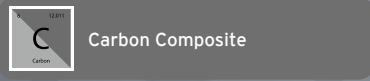

HQH LADCARB® FIX-LITE Leaning Applications

Anti-Slip Endings

Universal LADCARB TOP Anti-slip Ending is an essential part of most of the ladder applications. It prevents the ladder rails from slipping and also protects the rail ends from damage.

Despite the fact that it is recommended to be on the upper part of the ladder, it can be also used on the lower part if the situation does not allow turning of the ladder. Rubber Anti-Slip Foot is easily replaceable.



Top Ending



Bottom Ending



Stand-Off Devices

Mobile Stand-Off devices are essential parts of a hook ladder. They maintain the distance of the ladder from a wall assuring safe position of feet on the rungs.

These devices can be placed to any part of a ladder depending on the wall profile. They can be also used on the Emergency Stretcher to prevent contact of an evacuated patient with the ground.

Simple design consists of an aluminium clamp secured by a bolt with a wing nut and replaceable stand-off extenders with anti-slip rubber foot. Extenders are available at 2 different lengths. Special wing nut allows easy manipulation even with gloves and it is secured against unintentional release.



Mobile Stand-Off Device

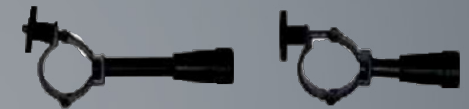

Stand Off Extenders



Universal STAND-OFF EXTENDERS with an M10 male thread can be attached to Mobile Stand-Off Device clamps, to Universal Bottom Endings and to LADCARB MARINE boarding ladder.

Extenders are available at 3 different lengths (100 mm, 150 mm) but the longest ones are mostly used only for MARINE boarding ladders.

Anti-slip foot made of special rubber prevents slipping and reduces noise when leaning against a wall or a ship hull.

FIX-LITE Window Breaker Applications

Window Breaking Plate

It is often difficult to break through windows covered by the advertising foil or anti-vandal film that is now widely used on buses.

The efficient method is to break the glass using a sharp-tip hammer and then smash it down with the heavy rubber window-breaking plate attached to the upper end of ladder. When the glass is pushed out the plate serves as an anti-slip wall support for the ladder.



LADCARB® Window breaking head.

Durable and efficient Window-breaking heads with hard-steel tips allow to use FIX-LITE ladders for breaking through windows of buildings, busses, trains and other vehicles.

For entering vehicles perfectly suit shorter versions of the ladders. Using a ladder for breaking through windows directly makes an assault entry much faster.



LADCARB® Raptor Anti-Slip Adapter.

The Raptor Anti-Slip adapters fit onto the end of a ladder to give a serrated tooth profile that grips on the edge of access points such as train doorways or window sills.



HQH LADCARB® FIX-LITE Rescue Applications

Rescue Kit

Rescue kit contains a stretcher cover which can be attached to 2 connected section of LADCARB LDC ladder. Fixing belts with safety buckles allow a victim to be transported at different angles.

It is suitable for any kind of technical rope rescue even in confined spaces.

Evacuation set of 6 loops, 4 carabiners with a rigging plate and a self-breaking descender can be used for evacuation by hand, winch or under a helicopter.



Evacuation Package

6 certified loops (4+1.5 m, 2+1.2 m)

Rigging plate

3 aluminium carabiners

1 steel carabiner

PETZL descender

Rescue Package

Stretcher cover with safety stripes

Spinal board

Neck fixator

Light bag



Internal attachment system that can be utilized by our Enhanced Variable Width Riggers Belt

HQH LADCARB® FIX-LITE Ladder Joining

Dual Ladder Connector B

Dual ladder connector consists of 2 aluminum clamps secured by bolts. Using a set of 2 these connectors allows to connect FIX-LITE ladders together for a fast entry of larger assault teams. Perfect for use in hostage evacuation situations.



HQH LADCARB® FIX-LITE Accessories

FIX-LITE Compact Frame Backpack



FIX LITE Transportation Bag



HQH LadCarb ATV/Quad Bridge

The LadCarb Carbon ATV/quad is an ultra-high modulus carbon fibre tube ladder which allows quad bikes of up to 650kg to cross ditches or brooks up to 3 metres long. It can also be used as a loading ramp, a single-track footbridge and as a multi-functional assault ladder which meets all requirements of the EN 1147 standard.

The whole set can be transported on the ATV rack and be deployed by one man in less than 3 minutes.

The standard set consists of six 4-rung sections which can be easily connected using ball-locking pins. Unique flexible connectors allow placing of track on uneven terrain. Anti-slip top and bottom endings not only protect the ends of stiles against damage but also allow use of the product as a leaning ladder.

Thanks to endurance of the structure, single or connected sections can also replace indispensable snow/sand recovery tracks.

MBS

Lean	Hook	Bridge
450kg	500kg	650kg



Carbon Composite



Available in Black and Sand



4kg per section



3.5m Max Reach



Bridge Ladder



Leaning Ladder



Hook Ladder



HQH LadCarb Urban Pole Ladder

A modular carbon fibre ladder that is compact and light, as well as being very robust. The system was designed for use in both Urban and Maritime environments. Each pole section is just 1m long which allows for easy transport in vehicles and facilitates covert use in confined, urban environments and in shallow water.

The standard ladder set of 4 sections can be built up into a 4m length which when used with a hook and wire ladder, gives an effective length of 6m. If a longer ladder is required additional sections can be added to give up to a 9.2m length ladder. The ladder can be used with a wide variety of hooks from both HQH and REBS with other accessories including wire ladders, flexible joints and stand offs. Weights are also available to counter the poles neutral buoyancy when diving.

Climbing the symmetrically installed rungs is fast, intuitive and secure in both boots and fins. The rungs have replaceable anti-slip tape.



 Hook Ladder

Mechanical Endurance
Test performed at extreme temperatures (+60c/-40c)

Fully compatible with all LADCARB accessories including assault platform adapters.

All material is tested for use in marine environments.

Will float in fresh and salt water.

MBS
Hook
300kg

 Carbon Composite

 Available in Black

 1kg per section

 9.2m Max Length

HQH LadCarb Urban Pole Ladder

Symmetrically installed rungs covered with replaceable anti-slip tape provide for comfortable and safe climbing and rest. Extremely strong carbon fibre tubes made by the most advanced axial fibre laying technology.

Suitable for all types of terrain. Mechanical endurance tests performed at extreme conditions (+60°C/-40°C).

Compact length of sections makes transportation and carrying very easy. Smart combination of the well-proved concept with symmetrical rung position allows comfortable and safer climbing and rest. Simple one-man operation. Different section lengths and rung layout can be made upon request.

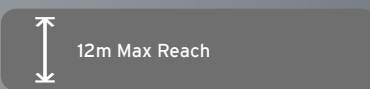
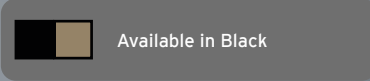
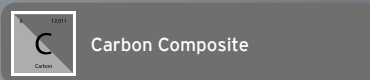
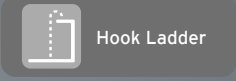
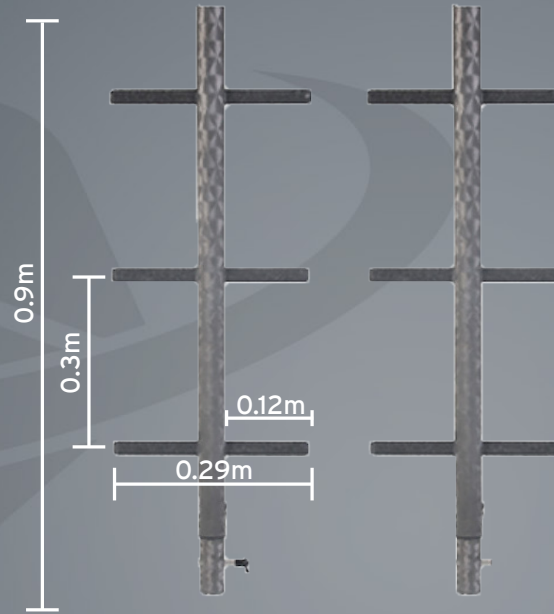

HQH Ladcarb VBSS Pole Ladder -
Mobile Stand-Off



HQH Wire Ladder 1,5m /2m
marine-grade 316L stainless steel

HQH LadCarb Pole Ladder VBSS

Lightweight LADCARB® POLE LADDER VBSS ladder with alternated rungs was designed for maritime interdiction operations. However, shorter (1.0 m) sections are suitable for urban operations as well. Strong but still flexible carbon tubes provide for precise manipulation with longer ladder versions and reduce stress on the ladder-hook connection. Thanks to our unique self-guided connectors it is impossible to connect sections with alternated rungs wrong way.

For diving operations we can make pole ladders with close-to-neutral buoyancy and the ladder can be further balanced by weights or floaters.

100% Carbon fibre tubes made by the most advanced axial fibre laying technology.



Ladcarb Universal Tactical Hook "Bt"(Titanium)



Lyon Compact Wire Ladder - Stainless Steel Sides - 2Mtrs long - 30cm spacing - Black Rungs - High Grip

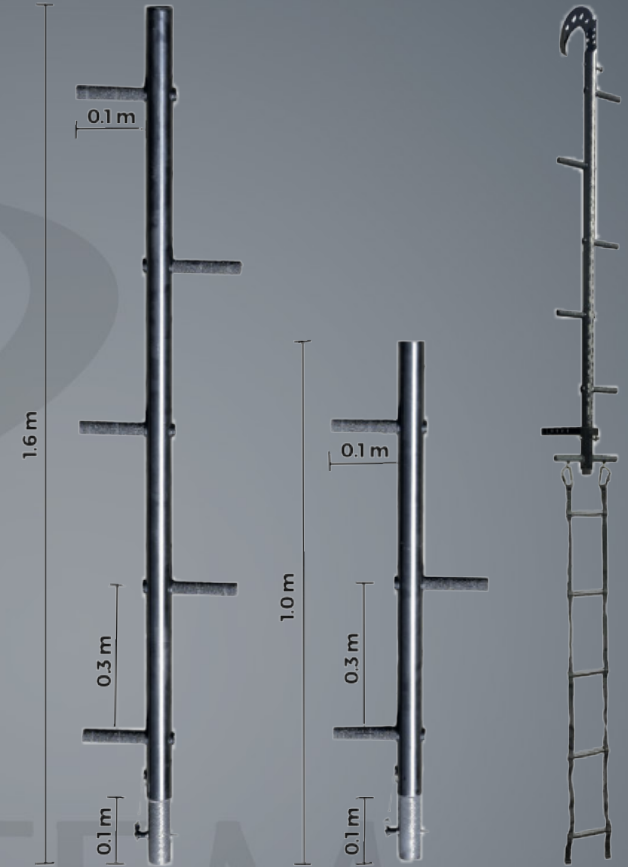

Fully compatible with all LADCARB accessories including assault platform adapters.

Mechanical Endurance Test performed at extreme temperatures (+60c/-40c)

All material is tested for use in marine environments.

Will float in fresh and salt water.



REBS Carbon Multi Ladder (CML)

The REBS Carbon Multi Ladder is a rigid, modular and multi-functional ladder system with a dual rail design. The system uses modular 90cm sections that can be locked together to create a ladder, stretcher or bridge. The CML can be used in multiple configurations such as being hung from an attachment point via a hook or hooks, leant against a wall, bridging a gap between buildings/containers or as a rigid stretcher with handles and a harness that holds the casualty securely. It is manufactured from carbon fibre for a combination of excellent rigidity and a light weight. The design was derived from the same advanced carbon fibre moulding techniques that are used to manufacture modern bike frames and optimizes carbon fibre properties to create a very strong monocoque frame where each 90cm section is moulded in one piece to minimise joints and weak spots. The ladder rungs are wide enough to easily get two boots onto a rung and all of the surfaces have a tough, high friction coating to make use as secure as possible.



MBS	Lean	Hook	Bridge
	300kg	1000kg	200kg

 Carbon Composite

 Available in Black

 1.8kg per section

 9m Max Reach

 Leaning Ladder

 Hook Ladder

 Bridge Ladder

 Emergency Stretcher

 Window Breaker



REBS Carbon Multi Ladder (CML) System Overview

REBS CML Sections for Leaning Ladder Application

To use as a leaning ladder, the Minimum angle is 75°. Connect four sections together without the bridge kit or six sections together with the bridge kit. There is a maximum of one operator at a time in this configuration. Use the rubber foot and top to hold the ladder in position and stop slipping.



Rubber Foot

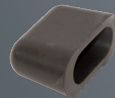

Rubber Top

Hanging Ladder Applications

1000kg Maximum Breaking Load when used a hooking ladder.

- Always use flexi elements.
- Use wall standoff to keep the ladder out from the wall.
- Use a wide wire ladder to add flexibility to the system or rubber feet to protect the bottom side.

Max 4 operators at a time. Max 11 sections (plus wire ladder).

The Carbon Multi Ladder was developed to use with REBS Tactical hooks, and used with either single or dual hook setup for scaling compound structures



Flexielement

Hook Configurations

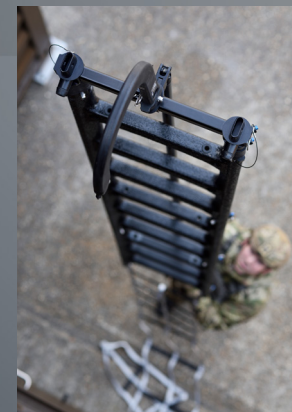

Tactical Hook 7" and 10"



Tactical Hook Dual 6.8"

REBS Carbon Multi Ladder (CML) System Overview

REBS CML for Bridging Applications

Another application of the CML System is bridging which can extend up to 5.4m across using the bridge line kit. The stretcher handles act as stands off to protect the carbon surface.

- Walk carefully, or crawl on both hands and feet. Do not run or jump.
- For use with 1, 2 or 3x sections there is no need for bridge kit, simply connect the desired amount of sections together.
- For use as bridge with 4, 5 or 6x sections, use the bridge line kit.

Limitations

- Maximum 1 operator at a time.
- Maximum 3 sections without bridge kit.
- Maximum 6 sections with bridge kit.



Bridge Line Kit for 6 sections

To begin using the bridge line kit prepare the necessary number of sections, handles, the top adapter with step fork and rope clamp, and the bridge kit. Connect the stretcher handles at the ends of the ladder. Then place the slings with carabiner in each of the ends. Clip in place the line assembly. One end should have the end of the rope with the eyelet and a pulley. The other end should have a pulley and a progress capture device.



CML Top Adapter with Pigg Release, Step Fork and Rope Clamp

Following on, place the top adapter with step fork onto the ladder on the middle. Turn the knob to open the clamp. Place the center line on the center groove on the rope clamp and the other two lines on their respective sides of the top adapter. Pull on the free end of the rope coming from the progress capture device to tighten the assembly. This tightening causes the sections to form a curve. Hand tighten firmly (about 20-30 kg load), but make sure not to over-tighten, as the next step will increase the tension further. Friction will vary with how the ropes are rigged and tightening force must be adjusted accordingly.

When properly tightened, lift the two lines and place them into their respective grooves on the rope clamp. The assembly should now be close to rigid.

Tighten the rope clamp gently, just enough to keep the clamp fixed onto the rope. Do not use excessive force. This will keep the top adapter from sliding on the rope.



REBS Carbon Multi Ladder (CML) System Overview

REBS CML for Stretcher Applications

- Connect two sections and 2 x 2 stretcher handles to create a simple and effective stretcher. The handles provide an easy and effective grip that keeps the patient lifted off the ground.
- Fasten the CML Harness backpack to the sections and use it to strap the patient firmly to the stretcher.
- The stretcher handles keep the stretcher off the ground and protect the hands of the users. The hand protectors also double as runners which makes single handed emergency evacuations by pulling the stretcher as a sled.



Handles and Quick Release Pin 12x35mm

Rubber Foot

Handles are kept in place by quick release pins. As well as the sections of the ladders.



REBS Carbon Multi Ladder (CML) System Overview

REBS CML for Scaffolding Applications

Additionally, CML has the unusual feature of scaffolding configuration. By using the angle connector to connect the sections together at an angle. Using the rubber feet, angle between ground and ladder (as illustrated at the leaning ladder) should be minimum 75°. Support with an additional operator whenever possible.



Angle Connector

Limitations

- Maximum 1 operator at a time.



CML Storage - Backpack



REBS Tactical Ladder

Fixed ladders, such as the Tactical Ladder are in many cases a more effective alternative than flexible ladders. The Tactical Ladder can be used in maritime operations and is also well suited for entering buildings or ledges in urban environments. It is extremely robust and is made from forged and anodized aluminium. With five ladder sections connected, along with the 1.5m Wire Ladder a total length of 10m can be achieved. Using the Wire Ladder alongside the Tactical Ladder offers several advantages:



Hook Ladder

MBS

Hook

1000kg



Aluminium



Available in Black



2.3kg per section



10m Max Reach





Suited for both maritime operations and for entering buildings or ledges in urban environments.

The ladder element, flexi element, hook and surrounding gear are connected with quick release pins.

REBS® Ultralight Pole Ladder (UPL)

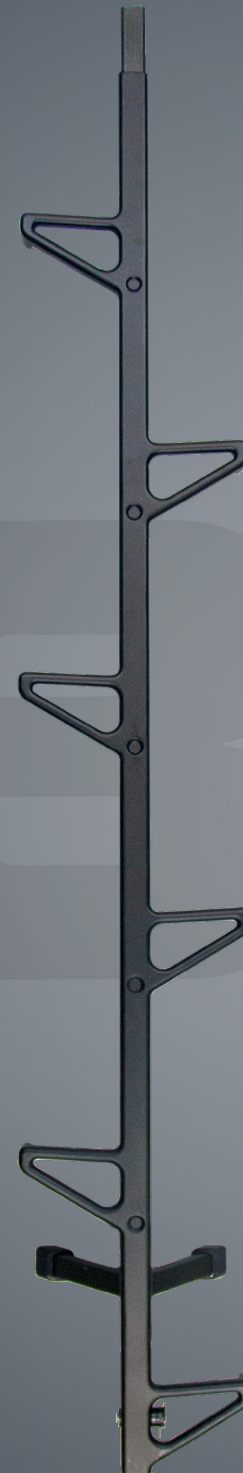
The Ultralight Pole Ladder (UPL) is REBS's latest single stile ladder which is lighter, easier to stack, carry, and stronger. Each UPL section is 1.7m and is molded using the latest in carbon fibre technology. The system can reach up to 11m when the top adapter, five sections of 1.7m, an optional single step and 1.5m Wire Ladder are all connected. The quick connectors and modular design make the system safe, fast and easy to assemble.



 Hook Ladder

MBS

Hook
2000kg

 Carbon Composite

 Available in Black

 1.7kg per section

 12m Max Reach



UPL Tactical Hook 7"



UPL Tactical Hook 10"

Quick connectors and modular design.

A lightweight rigid section ladder that can reach 11m whilst being operated by one person.

Can be used for RHIB, Dive and Urban operations.

Fully compatible with REBS® Tactical range of hooks, Single Step and Top Adapter.

REBS® Ultralight Pole Ladder (UPL) Junior

The REBS® UPL Junior is a half section of the Ultralight Pole Ladder that is optimised for urban use where the shorter length allows it to be packed / strapped to sack. The UPL Junior uses exactly the same construction techniques as the standard UPL but is just 0.85m long.

The UPL Junior does not have the built in stand-offs in order for it to be packed as compactly as possible - instead it uses push in pins that act as stand-offs.

The UPL junior uses the same system components - hook adapter / bottom step / wire ladder - as the standard UPL.



MBS
Hook
1200kg

Carbon Composite

Available in Black

0.9kg per section

12m Max Reach

Hook Ladder



UPL Junior Section

REBS® Ultralight Pole Ladder Adapters

To achieve a 12m high ladder hang, REBS® Ultralight Pole Ladder must be used alongside its accompanying components.

Aluminium Tactical hooks attach via Top adapter.

Single step clips the bottom section to provide additional support and steadyness.

Attach the REBS® wire ladder with connectors to gain maximum height.



Top Adapter

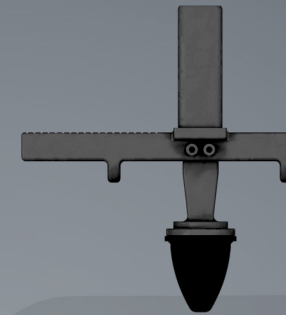

Single Step



REBS Wire Ladder 1,5m



REBS Hook Dual 6,8" Tactical

TIC Tools Folding Carbonfiber Tactical Ladder

Revolutionary 11.5 ft. (3.5M) carbon-fiber folding tactical ladder. Ladder gives the user a 15 ft reach yet folds to a compact size to be easily carried in the backpack. Amazingly light. Rated for 350 lbs. capacity at 70 degree incline. Folding hinges automatically lock into place. No pins to insert or become lost. Ladder is available in black, green and grey colors.

Ladder includes carbon fiber hooks that install to the top of the ladder for building accents. Also includes custom, lightweight backpack.



MBS	Lean	Hook
	159kg	

Carbon Composite

Available in Black

1kg per section

4.5m Max Reach



- Leaning Ladder
- Hook Ladder

Telesteps Rescue Telescopic Ladder

The Telesteps Rescue Telescopic Ladder is a fast access system that simply pulls out to the required length to get over walls and into first floor entrance points.

It is the only telescopic ladder rated to take three heavily laden people at a time with a total weight of 500kg.

It is also the only telescopic ladder to be certified to EN Rescue Standard EN 1147. There are several ladder standard; telescopic ladders sold in the EU should be certified to EN131 as a minimum - this is the standard for domestic or light industrial use, but these ladders rarely stand up to abuse for very long and are only rated for one person at a time (150kg).

EN 1147 is the standard for Rescue ladders and requires the ladder to be a lot more robust than those certified to EN131 - these ladders have been designed for rescue scenarios where a casualty is being carried down the ladder by two rescuers in challenging environments where speed is a priority and delicate handling of equipment unlikely.

Available in two length and weight options.



- MBS

Lean
300kg
- AI

Aluminium Collapsible Monopole Ladder System
- Available in Black
- ✎

15kg / 19.2kg
- ↑↓

4.3m / 4.9m
- Leaning Ladder

Product Name	Working Height	Weight	Width
Telesteps Rescue Telescopic Ladder (3.5m)	4.3m	15kg	0.47m
Telesteps Rescue Telescopic Ladder (4.1m)	4.9m	19.2kg	0.47m



Connect With Us





Keep updated with Helix operations across platforms such as helixoperations.com, Tactical and Rescue Instagram accounts as well as LinkedIn. We share exciting information regarding products we manufacture ourselves as well as key products from brands we work with.

Stay informed with key innovations across all product ranges in the tactical and rescue field as well as new courses.

Our website lists our entire range, including any certifications, technical specifications, and variations of products. You can also find information regarding courses and training, including our accreditation.

 helixoperations.com

 [@helixoperations](https://www.instagram.com/helixoperations)

 [helixoperations](https://www.facebook.com/helixoperations)

 [helix-operations-limited](https://www.linkedin.com/company/helix-operations-limited)



Helix Operations evolved out of DMM International when it became apparent that there was a need for a specialist company to support the government, tactical, and rescue markets.

DMM International has a global reputation as a leading manufacturer of superior height safety equipment and has supplied the UK and overseas military and government institutions with equipment since 1985. Growing demand for a broad range of complete, specialist systems where all components are selected and proven to work together led to Helix being founded on this broad wealth of expertise and experience. With a remit to bring together a portfolio of the best equipment, the resulting partnerships with companies such as REBS, CTOMS, and Atlas amongst others have allowed us to offer a complete capability for vertical access and rescue across Urban, Mountain, and Maritime environments.

Helix's mission is to provide the tactical end user with the very best equipment and systems for vertical access, egress, and rescue scenarios.

We understand that first class equipment is only one part of the equation, and that without a trained operator or enabler it is unlikely to be utilised to its true capacity. That is why Helix also offers training packages alongside systems and kit. Training can be delivered through a range of options; from standard courses for the operator, maintainer, or supervisor, through to bespoke courses covering specific scenarios. These training courses are either accredited by Helix or through external validation depending on the end user requirement and course syllabus.



Woodlands House
Parc Britannia
Parc Menai
Bangor
Gwynedd
LL57 4FA

sales@helixoperations.com